

# Series-Parallel Resistors Catalogue

Taisir Avilés  
veotos@gmail.com

January 15, 2025

## 1 Introduction

Two-terminal series-parallel networks of resistors are represented here up to  $n = 8$  elements.<sup>1</sup>

Each combination is depicted in a subfigure (within a Figure that may span multiple pages) with its corresponding equivalent resistance below, next to the number (in parentheses) of the subfigure. Combinations with the same number of elements are sorted in ascending order according to their equivalent resistance.

$n$	$s_n$
1	1
2	2
3	4
4	10
5	24
6	66
7	180
8	522

Table 1: Series-Parallel Network Numbers

---

<sup>1</sup>There are 1532 different series-parallel networks with  $n = 9$  elements. Please, let me know if you need the combinations for a number of elements greater than  $n = 8$  and why.



(1)  $R$

Figure 1:  $n = 1$

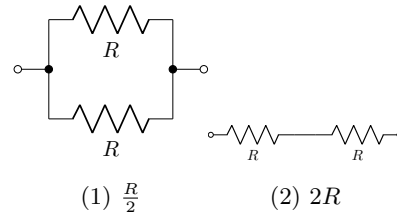

Figure 2:  $n = 2$

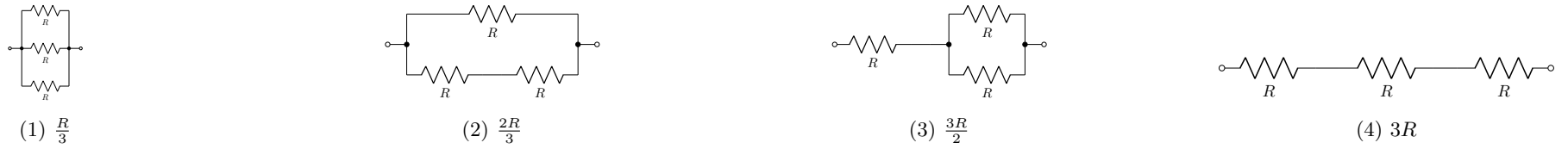

Figure 3:  $n = 3$

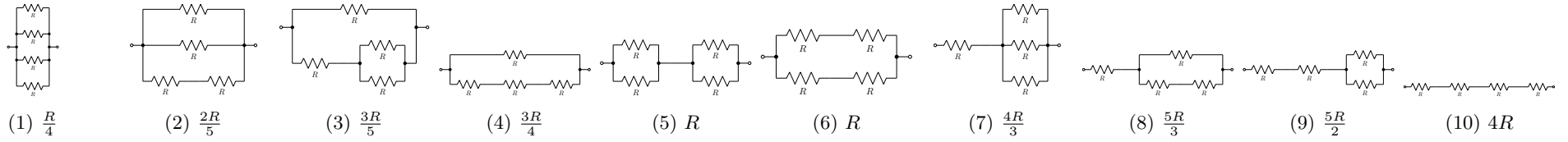

Figure 4:  $n = 4$

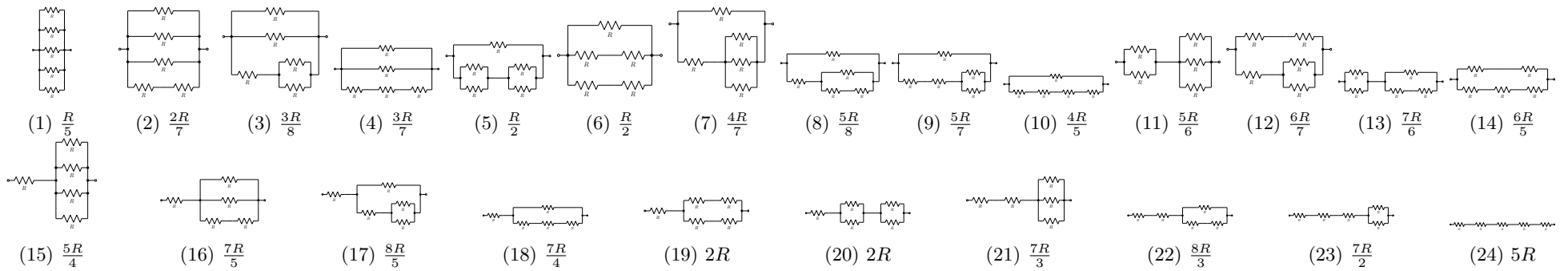

Figure 5:  $n = 5$

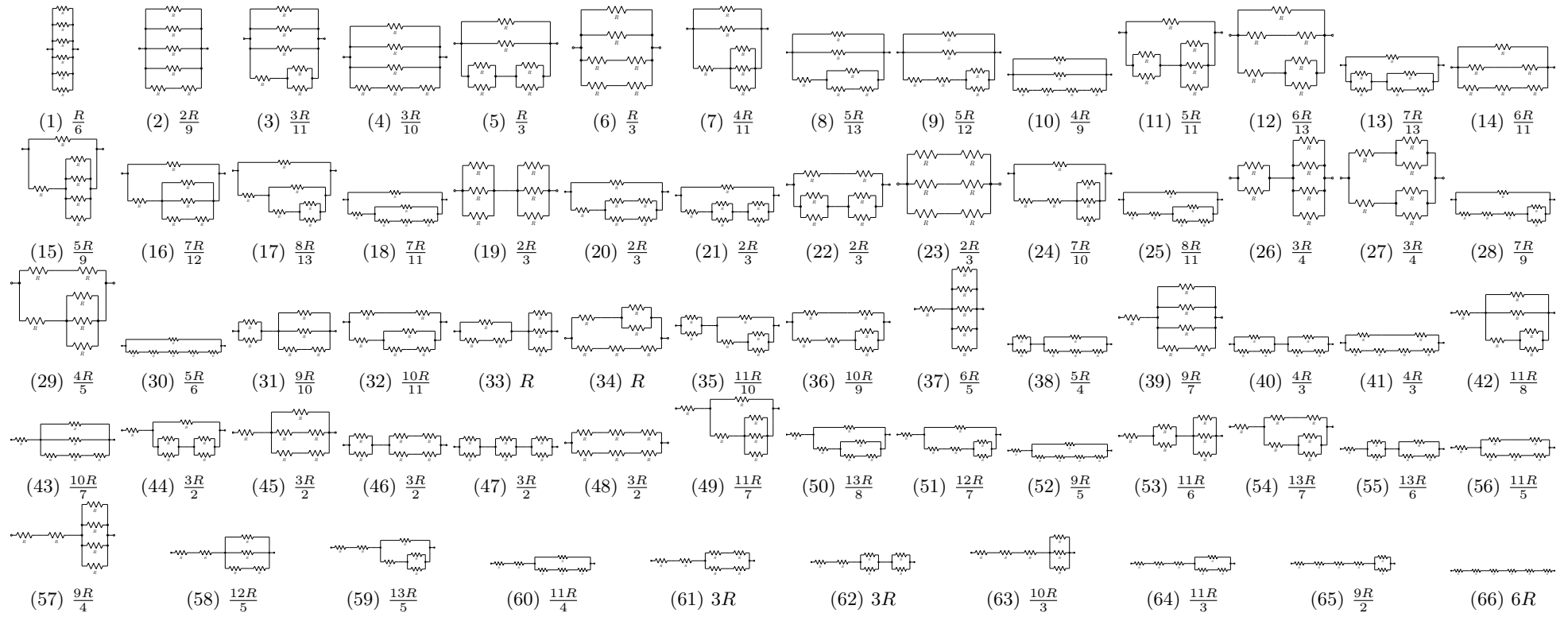

Figure 6:  $n = 6$

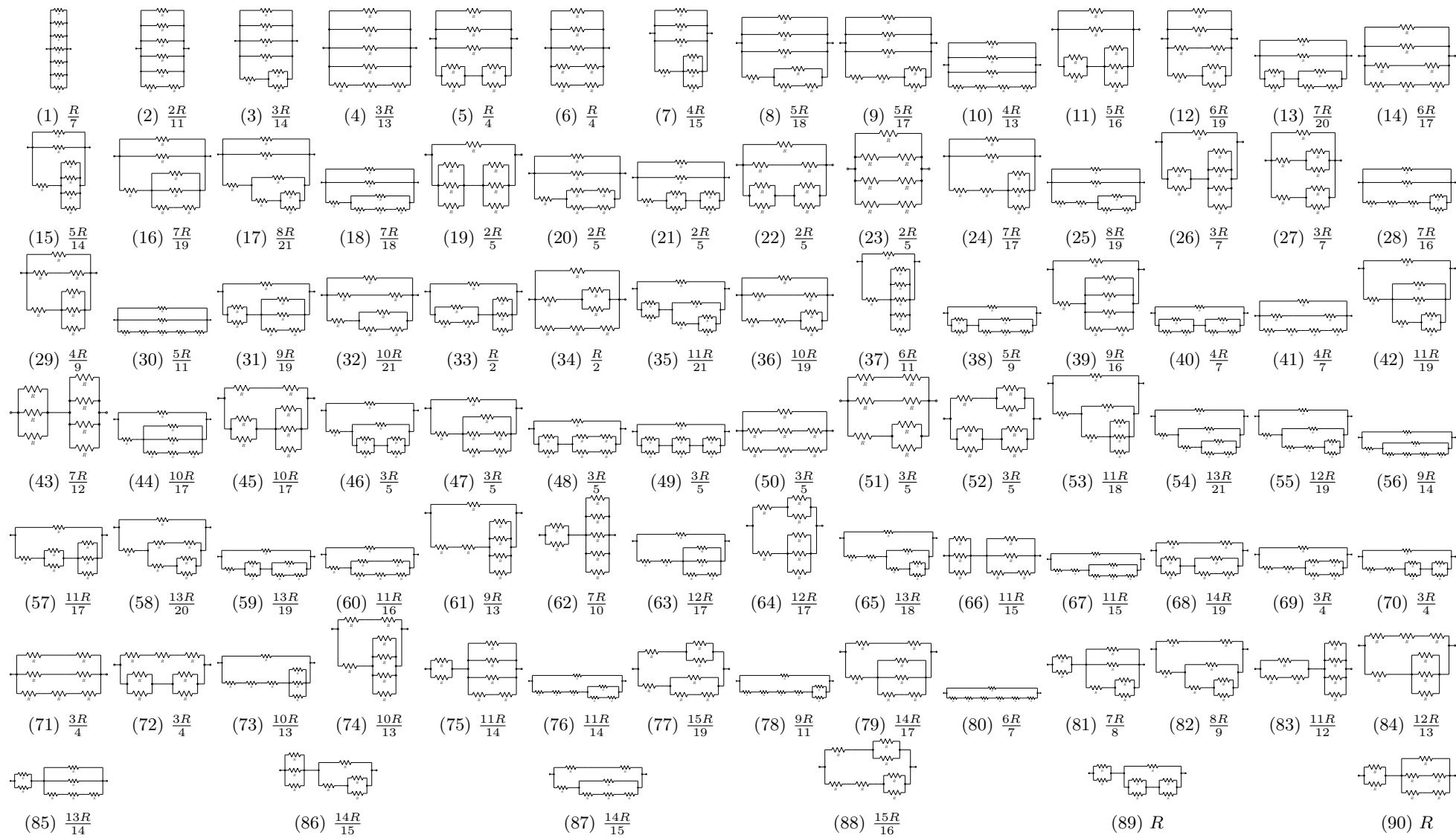

Figure 7:  $n = 7$  (1 of 2)

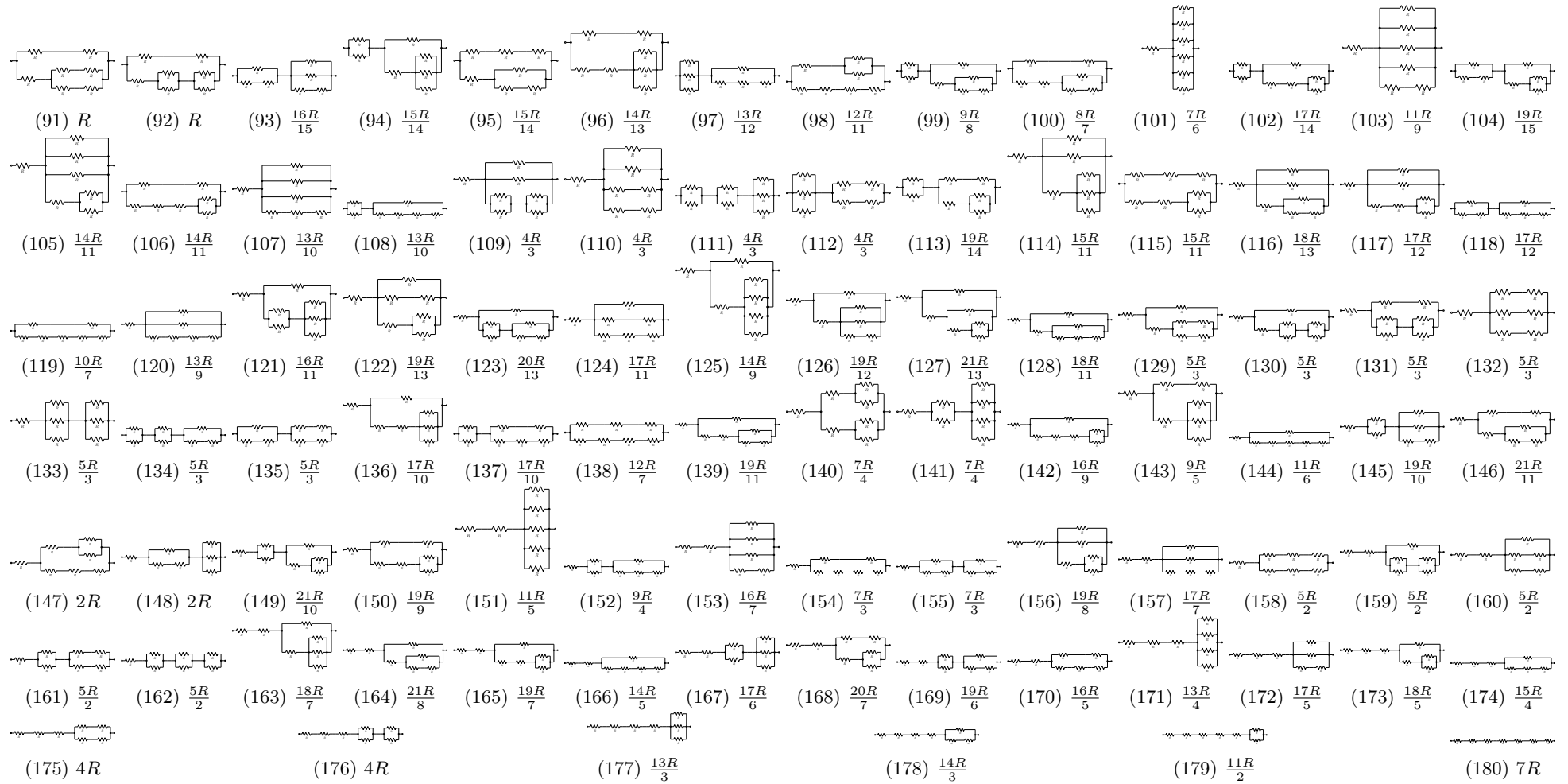

Figure 7:  $n = 7$  (2 of 2)

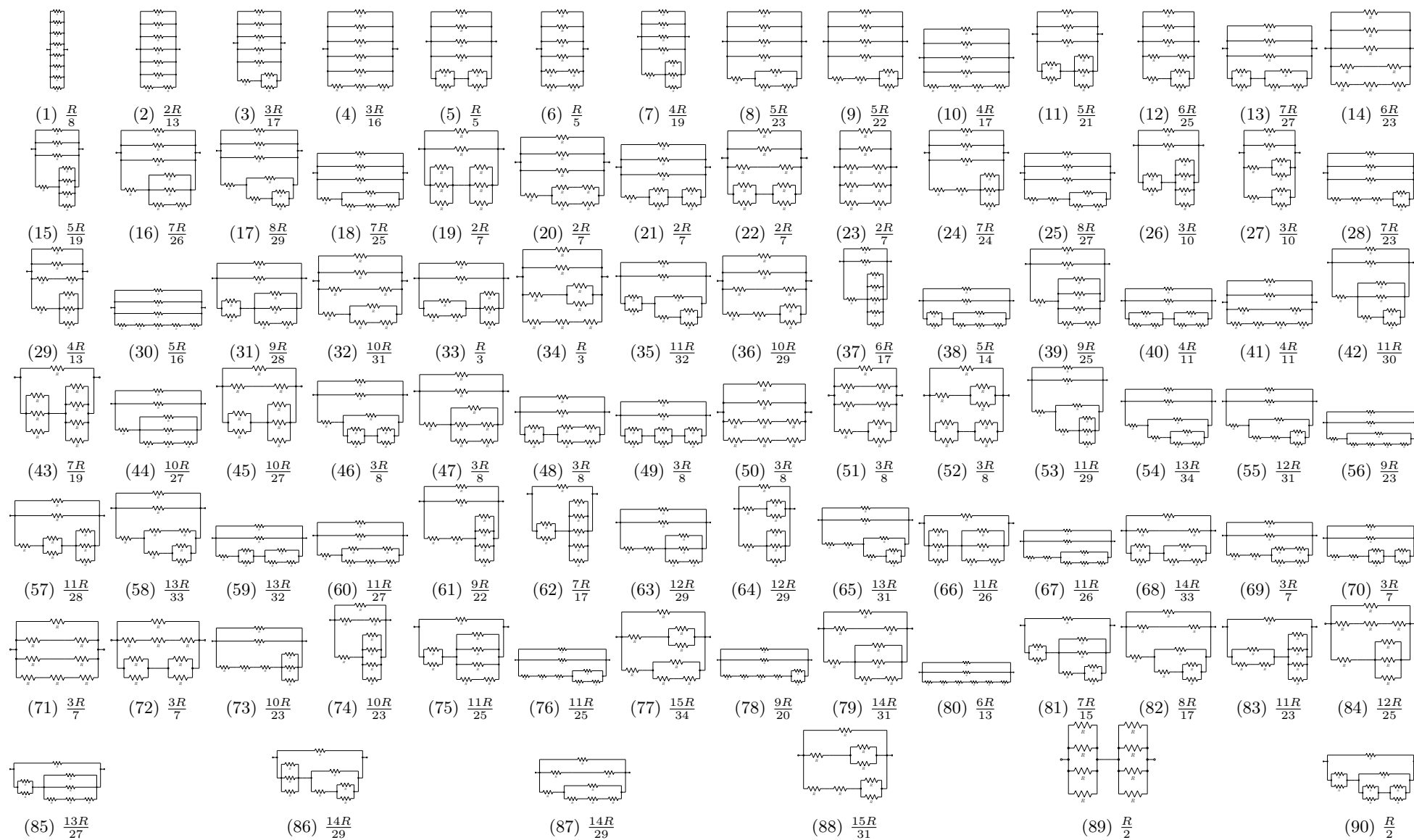

Figure 8:  $n = 8$  (1 of 6)

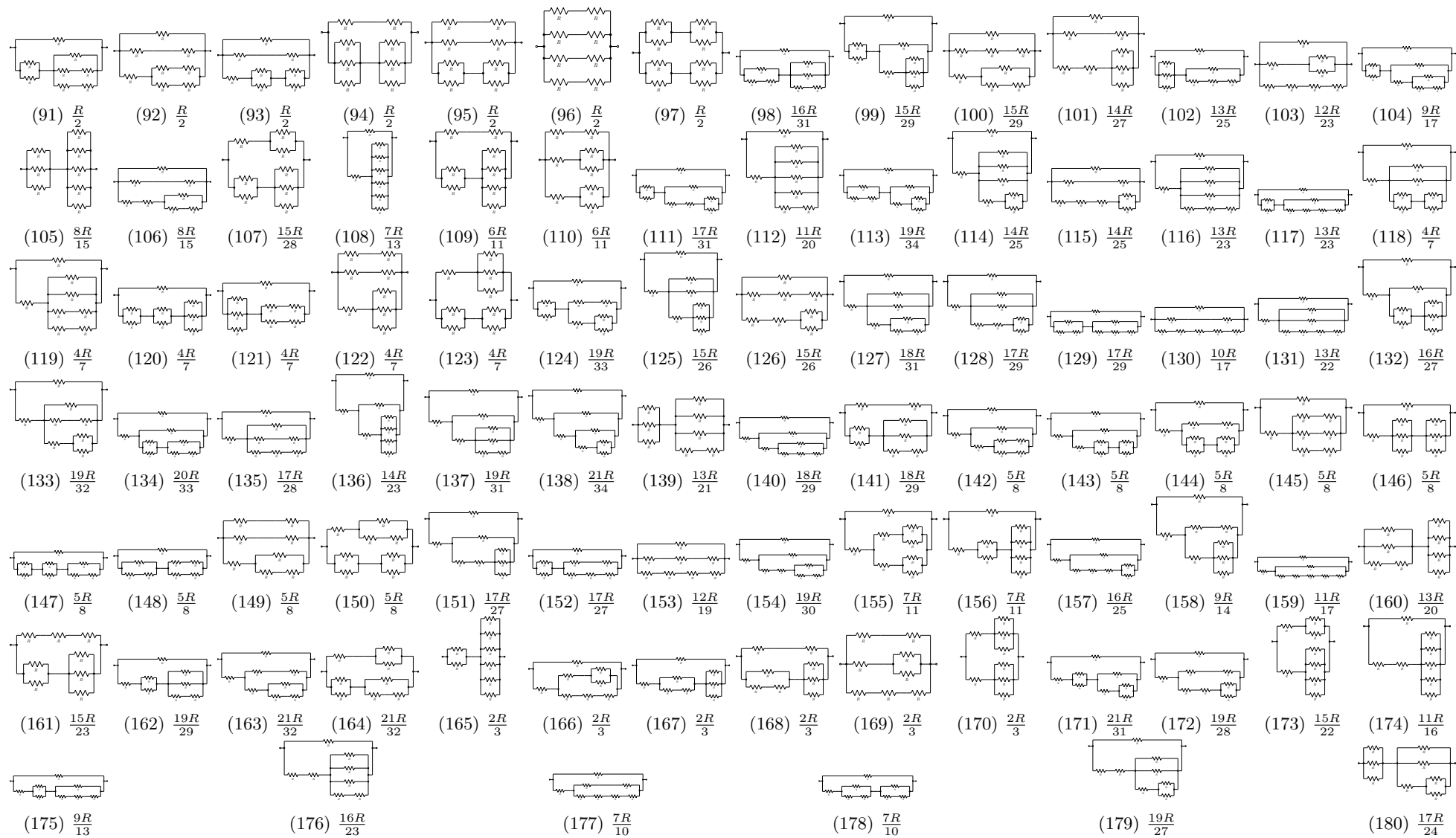

Figure 8:  $n = 8$  (2 of 6)

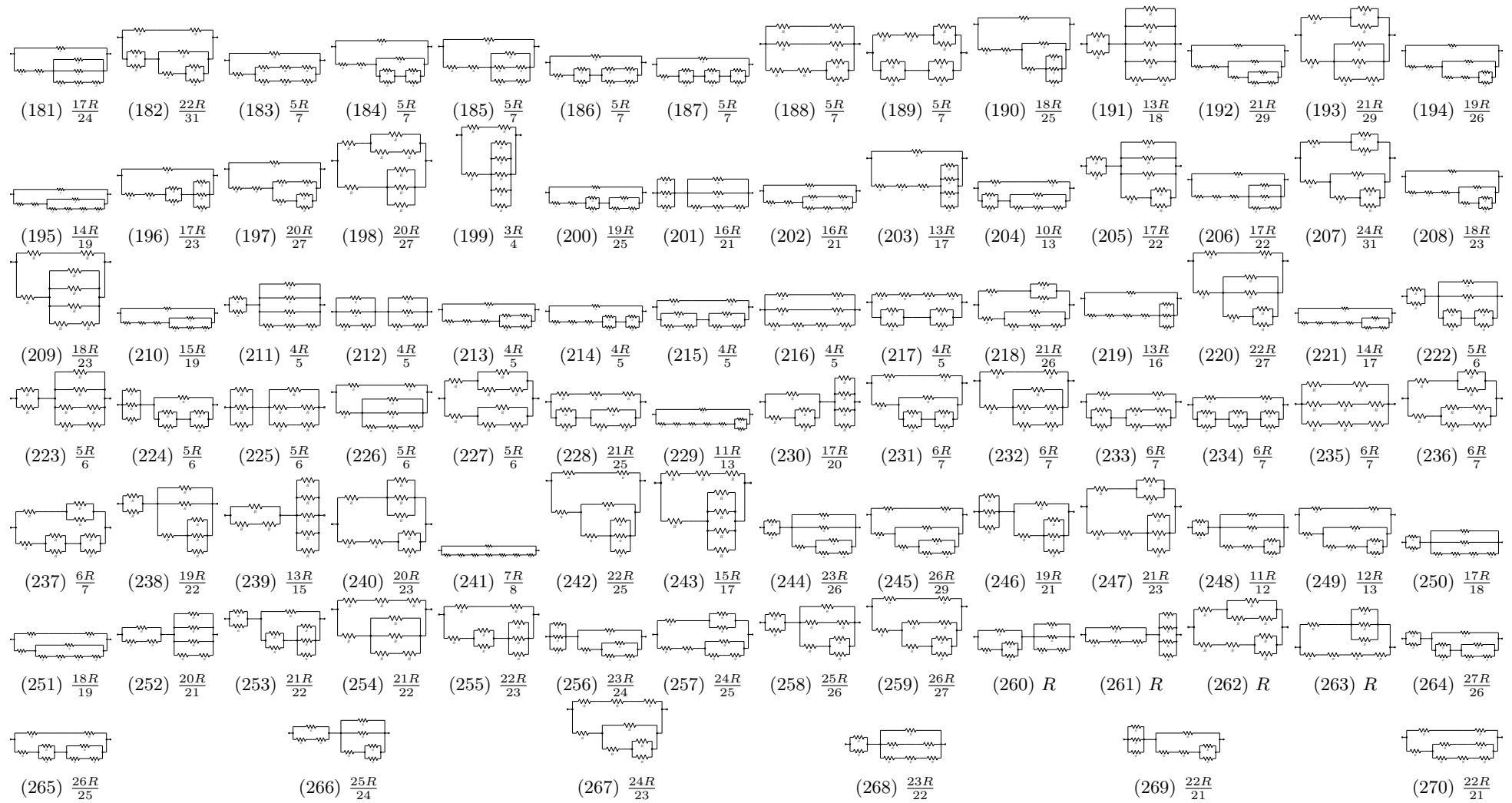

Figure 8:  $n = 8$  (3 of 6)



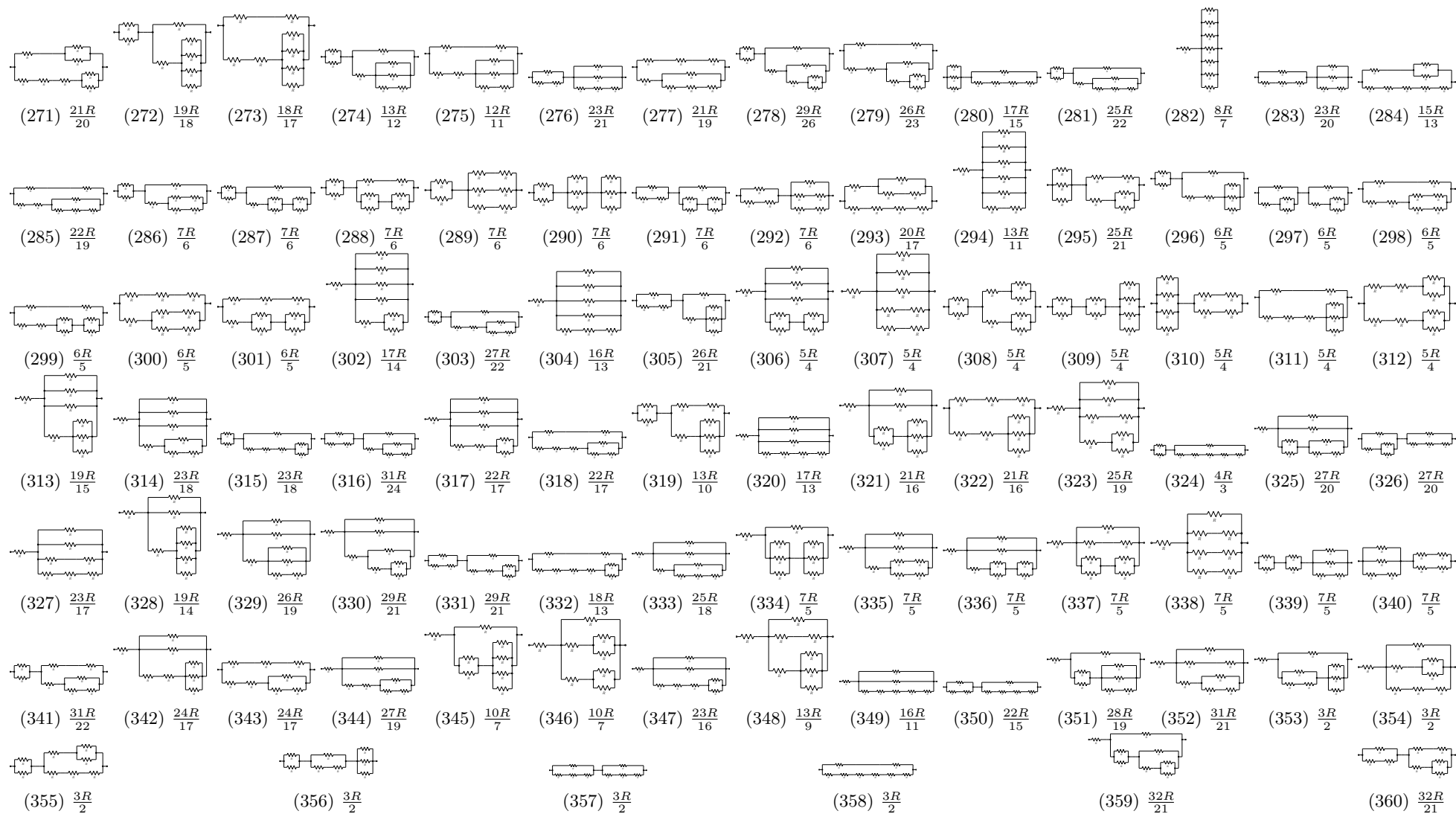

Figure 8:  $n = 8$  (4 of 6)

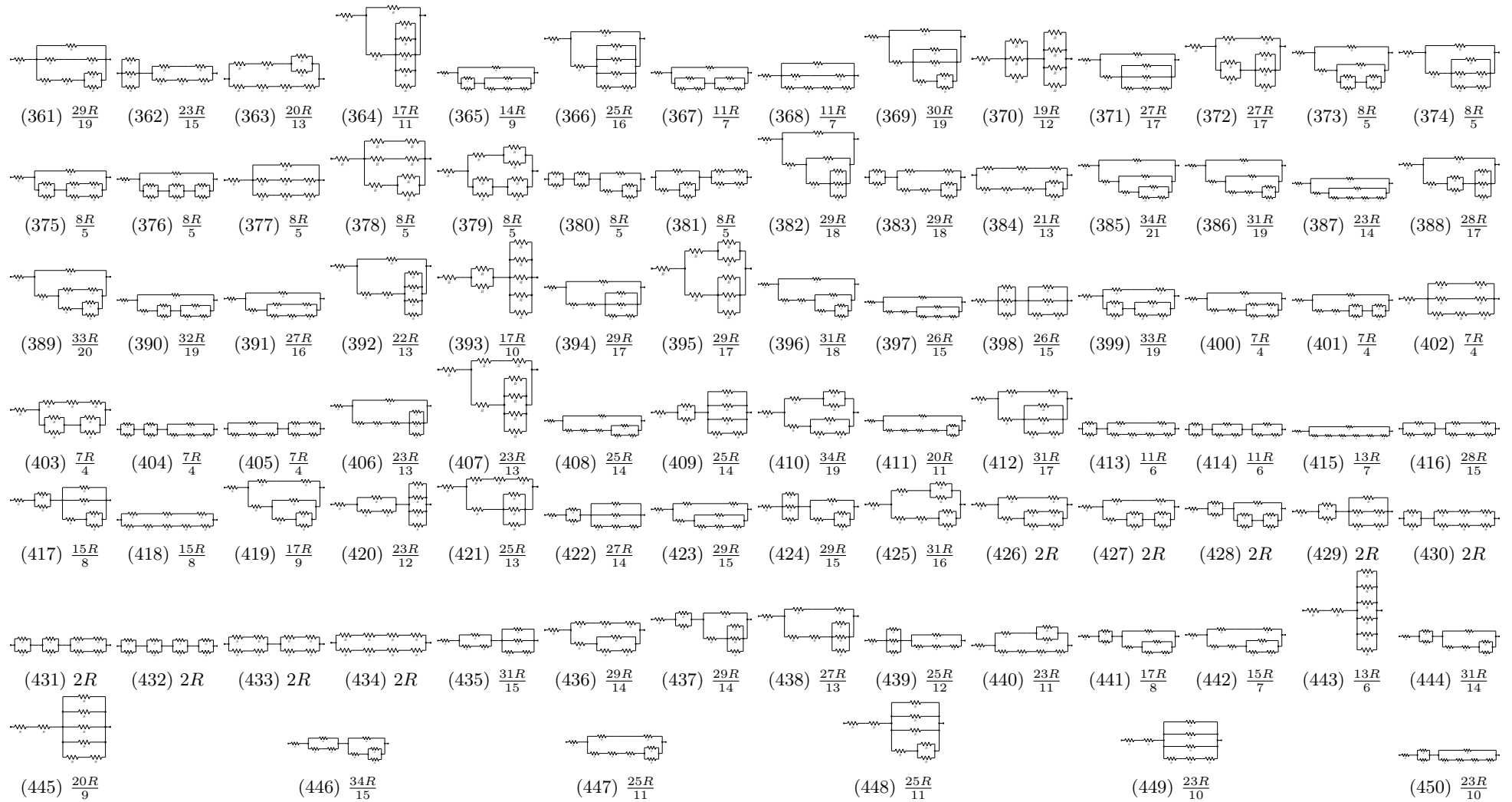

Figure 8:  $n = 8$  (5 of 6)

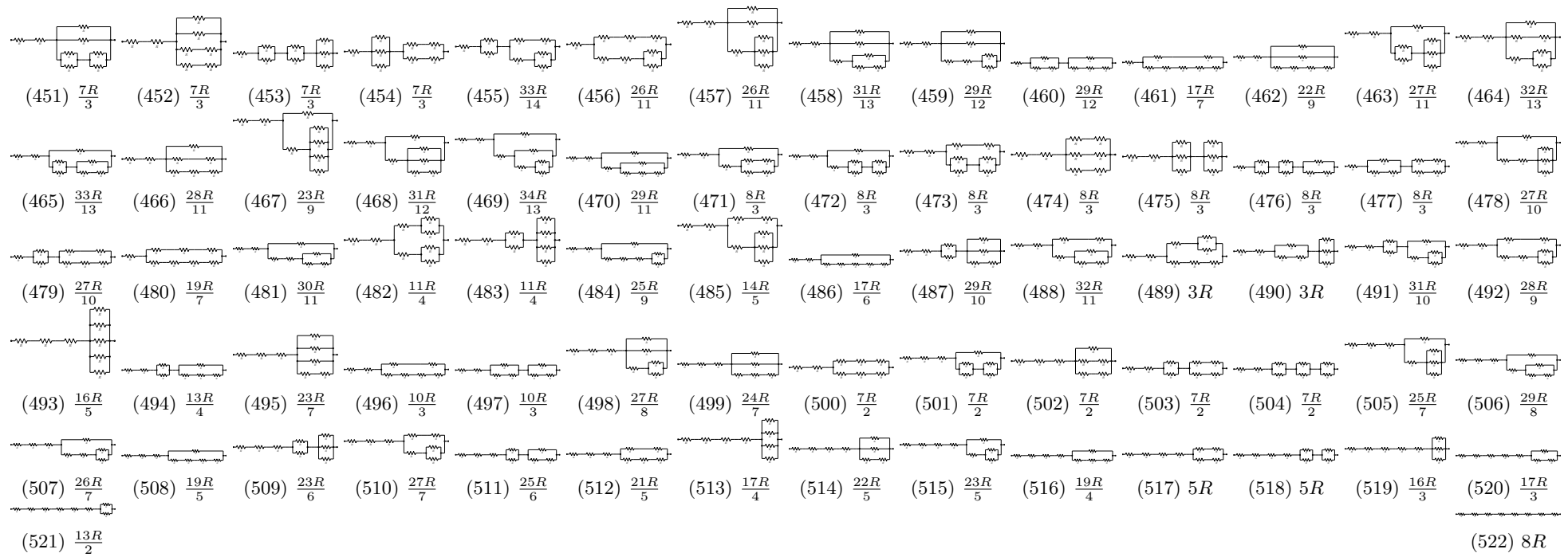

Figure 8:  $n = 8$  (6 of 6)